



# Product Data Sheet

## LPMM-7-27

Low profile MiMo LTE & cellular antenna

C/Note	Doc Issue	Date	Approval
01019	1	07.06.2013	J.J.

PANORAMA  ANTENNAS

# LTE MIMO Antenna

## Low Profile MIMO Antenna



### LPMM-7-27

Rugged low profile design

2x Wideband LTE/cellular elements

The Panorama LPMM low profile MIMO antenna range has been designed to support the new generation of vehicular LTE routers.

The antenna enclosure contains two isolated high performance antenna elements covering 698-2700MHz MiMo / diversity at cellular / LTE frequencies.

The antenna does not require a metallic ground plane, and maintains a high level of performance even when mounted on a non-metallic surface.

### Technical Drawing

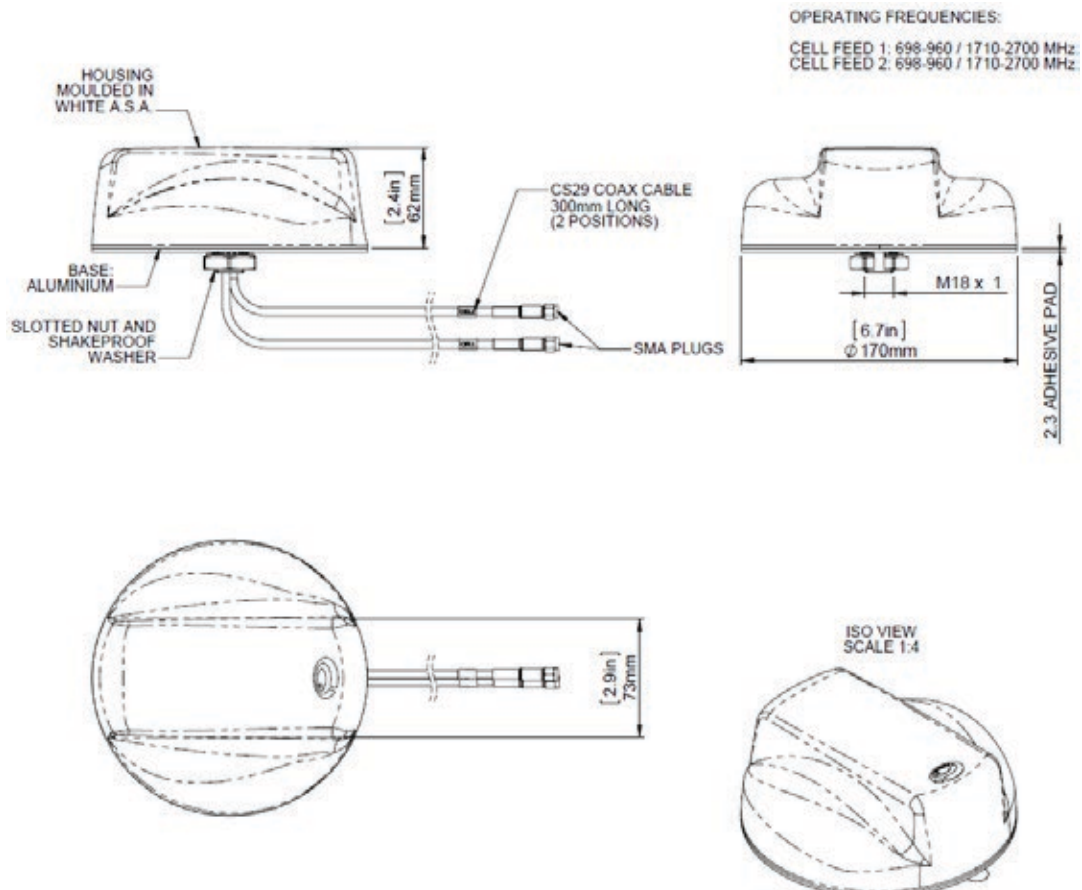

# LTE MIMO Antenna

## Low Profile MIMO Antenna

<b>Part No.</b>		LPMM-7-27
<b>Electrical Data</b>		
Frequency Range (MHz)	Elements 1 & 2	698-960 / 1700-2700
Operational Bands	Elements 1 & 2	LTE / Cellular
Peak Gain: Isotropic	Elements 1 & 2 -698-960	2.3dBi
	Elements 1 & 2 -1700-2700	5dBi
VSWR	Elements 1 & 2	< 2.5:1
Isolation (in free space)	Elements 1 & 2	> 15dB
Polarisation		Vertical
Impedance		50Ω
Max Input Power (W)		50
<b>Mechanical Data</b>		
Dimensions	Height	2.4" (62mm)
	Diameter	6.7" (170mm)
Operating Temp		-22° / 176°F (-30° / +80°C)
Material		A.S.A & diecast aluminium
Colour		White
<b>Mounting Data</b>		
Mounting type		Panel mount
Max panel thickness		0.236"(6mm)
Mounting hole		3/4" (19mm)
<b>Cable Data</b>		
Cell / LTE Cables x2	Type	CS29 (double shielded RG58)
	Diameter	0.2"(5mm)
	Length	1' (0.3m)
	Termination	SMA (male)

# LTE MIMO Antenna

## Low Profile MIMO Antenna

Typical VSWR cellular / LTE elements\*

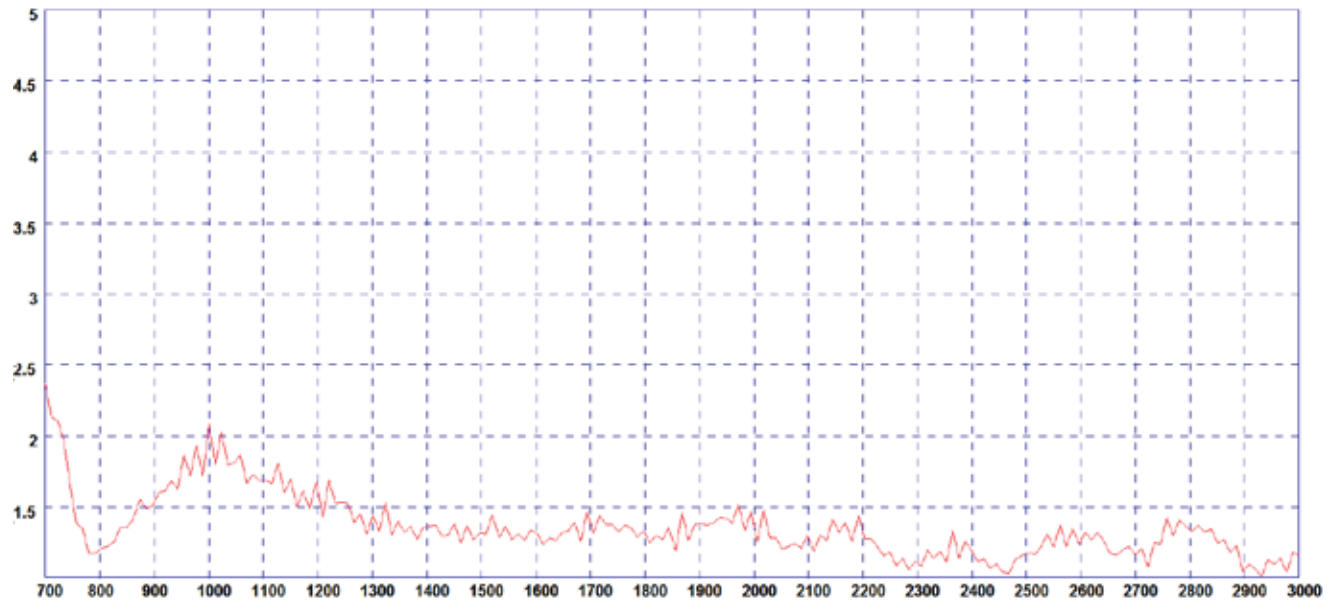

\* VSWR measured in free space with 4.5m (15') of CS29 cable.

Typical Isolation cellular / LTE elements\*

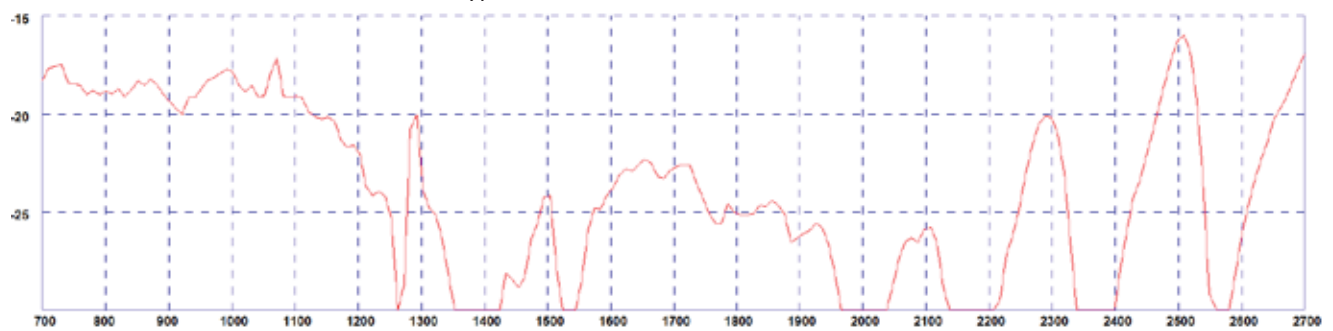

\* Isolation measured in free space with 300mm (1') of cable.

# LTE MIMO Antenna

## Low Profile MIMO Antenna

Typical 3D Pattern - Elements 1&2 700MHz

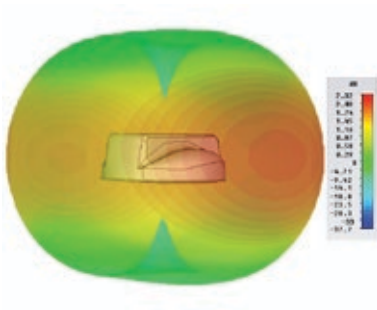

Typical 3D Pattern - Elements 1&2 800MHz

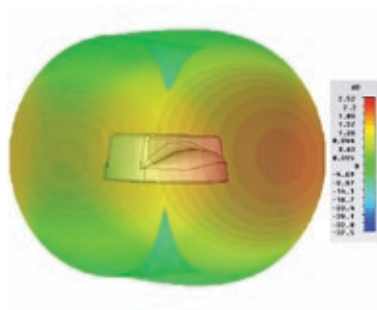

Typical 3D Pattern - Elements 1&2 900MHz

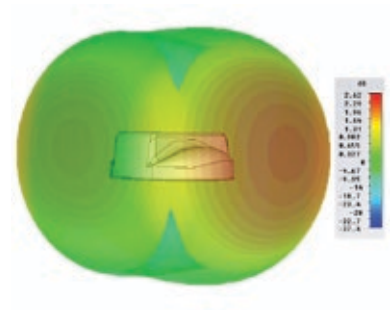

Typical 3D Pattern - Elements 1&2 1800MHz

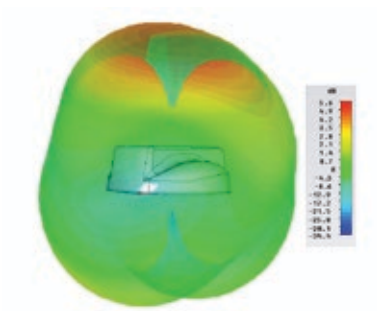

Typical 3D Pattern - Elements 1&2 1900MHz

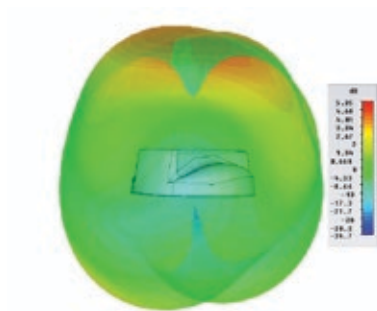

Typical 3D Pattern - Elements 1&2 2100MHz

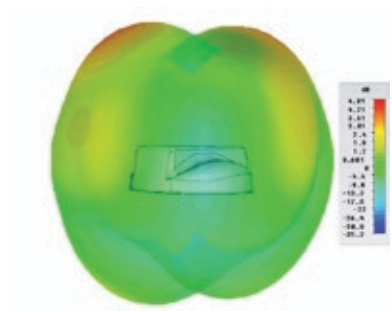

Typical 3D Pattern - Elements 1&2 2400MHz

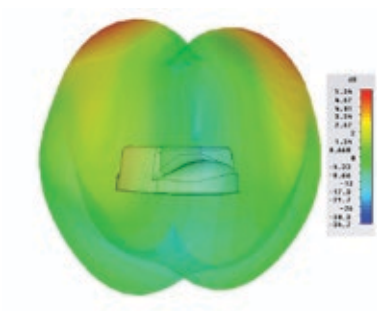

Typical 3D Pattern - Elements 1&2 2500MHz

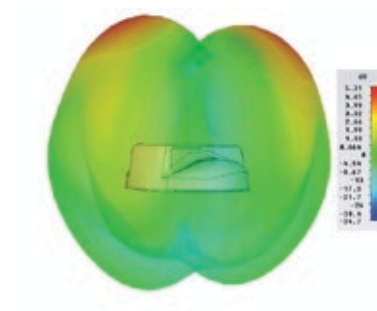

Typical 3D Pattern - Elements 1&2 2600MHz

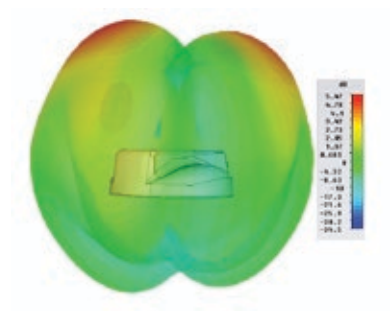

N.B. All pattern and gain measurements taken in free space without additional ground plane.

**Panorama Antennas Ltd**

Frogmore, London, SW18 1HF, United Kingdom

T: +44 (0)20 8877 4444

F: +44 (0)20 8877 4477

E: [sales@panorama-antennas.com](mailto:sales@panorama-antennas.com)

[www.panorama-antennas.com](http://www.panorama-antennas.com)

Waiver: The data given above is indicative of the performance of the product/s under particular conditions and does not imply a guarantee of performance. These specifications are subject to change without notice.

Copyright © Panorama Antennas Ltd. All rights reserved.

PANORAMA  ANTENNAS